



<https://hps.vi4io.org>

Christian Köhler

Introduction to Git

A free and open source VCS

Table of contents

- 1 Introduction
- 2 Setup and Configuration
- 3 Creating commits
- 4 Managing branches

Learning Objectives

- Know the purpose of VCS in general and Git in particular
- Set up and configure Git
- Create local and clone remote repositories
- Craft and review commits
- Interact with local and remote branches

Why version control systems (VCS)?

- Track changes in your project
- Be able to jump to the last known working state
- Explore different (potentially experimental “throwaway”) branches of development
- Attach meaningful notes to each set of changes aka. “commit”
- Collaborate with others

What is Git?



- Initial release in 2005 by Linus Torvalds
- Used for developing the Linux Kernel
- Previously: BitKeeper (proprietary)

What is Git?



- Initial release in 2005 by Linus Torvalds
- Used for developing the Linux Kernel
- Previously: BitKeeper (proprietary)

What is Git?



- Initial release in 2005 by Linus Torvalds
- Used for developing the Linux Kernel
- Previously: BitKeeper (proprietary)
- <https://git-scm.com/>
 - ▶ Documentation
 - ▶ Git command reference

What is Git?



- Initial release in 2005 by Linus Torvalds
- Used for developing the Linux Kernel
- Previously: BitKeeper (proprietary)
- <https://git-scm.com/>
 - ▶ Documentation
 - ▶ Git command reference
 - ▶ Ebook: *Scott Chacon, Ben Straub - Pro Git*



Git terminology

- Git projects are called *repositories*.
- Fully distributed, i.e. each local clone contains the entire project history
- Versions of the managed file tree are called *commits*.
- They form a graph where each new commit has at least one parent.
- Branches are easily created - they're just named pointers to commits.
- HEAD points to the branch that will receive the next commit.
- Important commits (e.g. release versions) can get a named (even annotated, signed) *tag* pointing to them.

Fundamental Structure: Directed Acyclic Graph (DAG) of commits

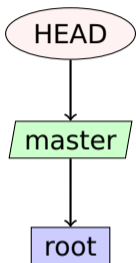

Fundamental Structure: Directed Acyclic Graph (DAG) of commits

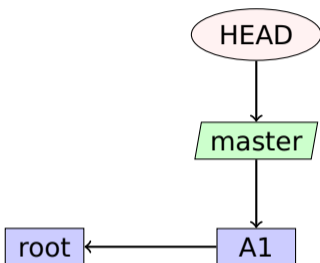

Fundamental Structure: Directed Acyclic Graph (DAG) of commits

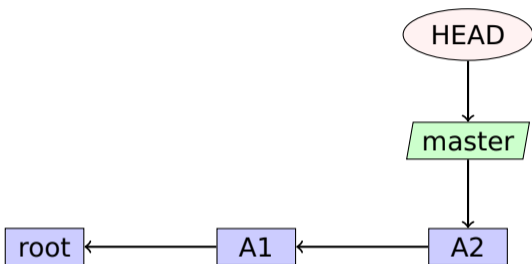

Fundamental Structure: Directed Acyclic Graph (DAG) of commits

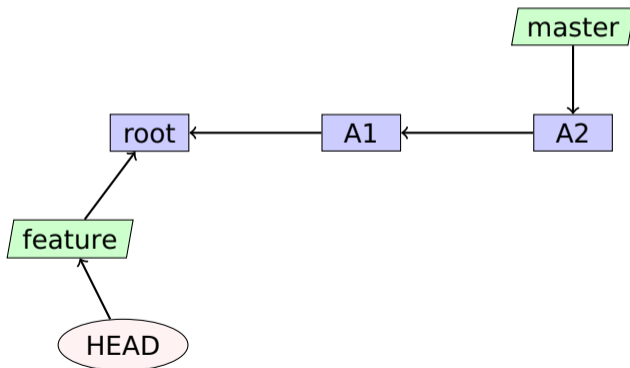

Fundamental Structure: Directed Acyclic Graph (DAG) of commits

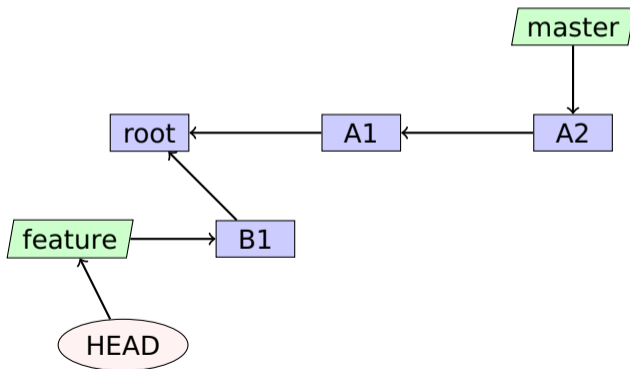

Fundamental Structure: Directed Acyclic Graph (DAG) of commits

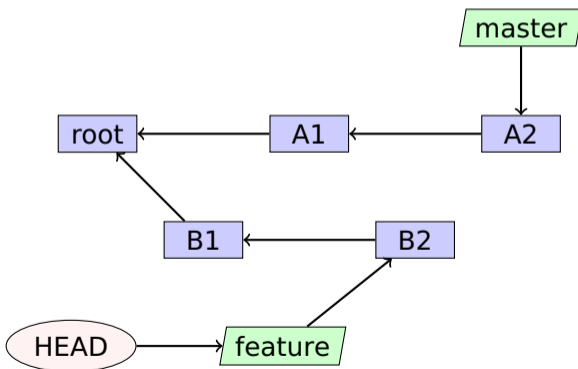

Fundamental Structure: Directed Acyclic Graph (DAG) of commits

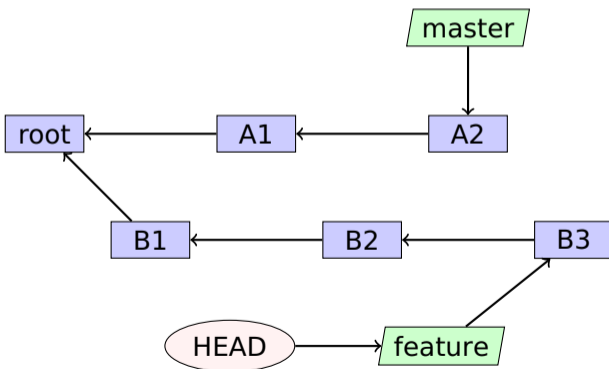

Fundamental Structure: Directed Acyclic Graph (DAG) of commits

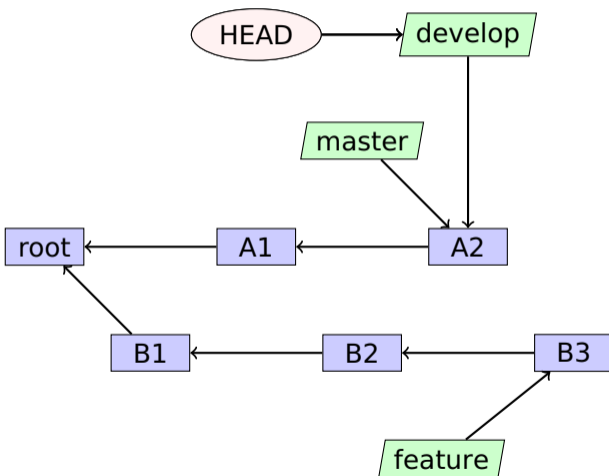

Fundamental Structure: Directed Acyclic Graph (DAG) of commits

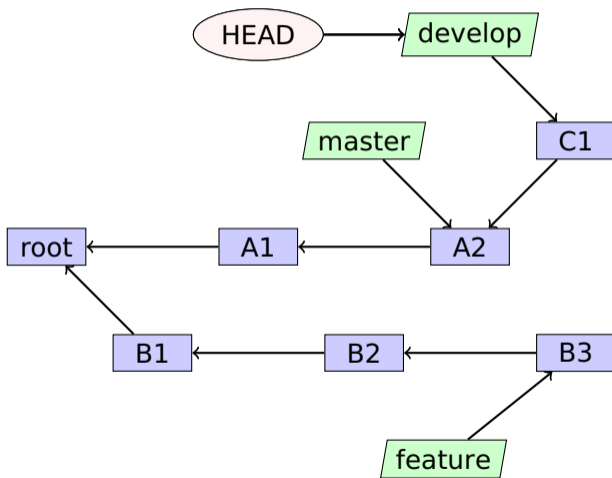

Fundamental Structure: Directed Acyclic Graph (DAG) of commits

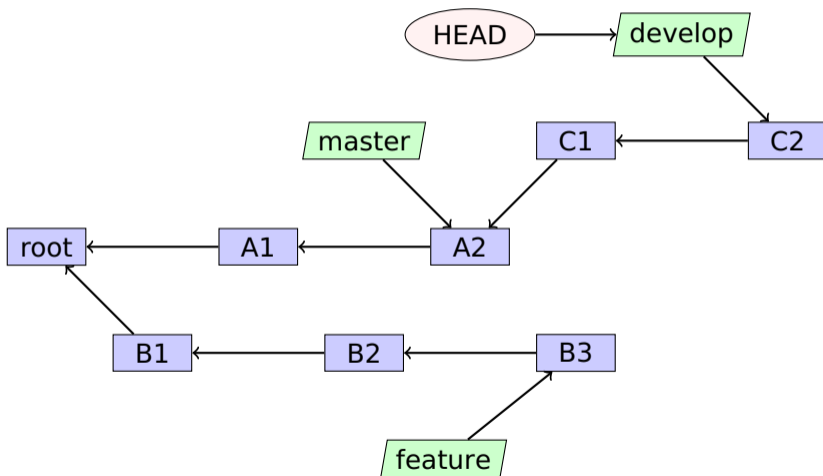

Fundamental Structure: Directed Acyclic Graph (DAG) of commits

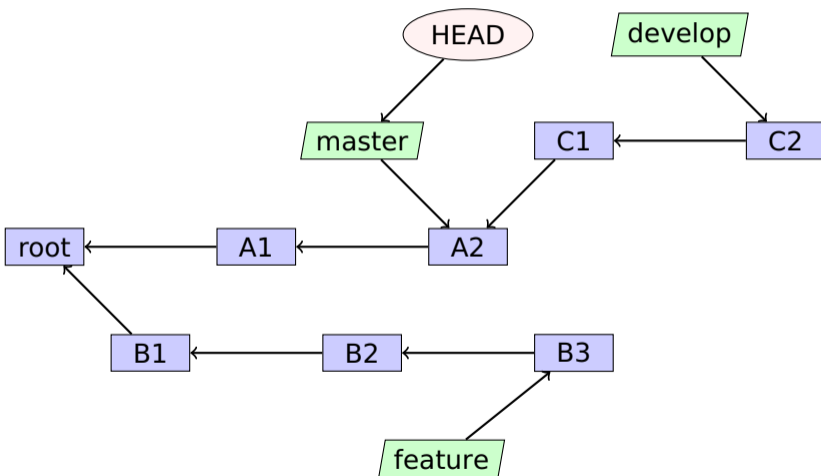

Fundamental Structure: Directed Acyclic Graph (DAG) of commits

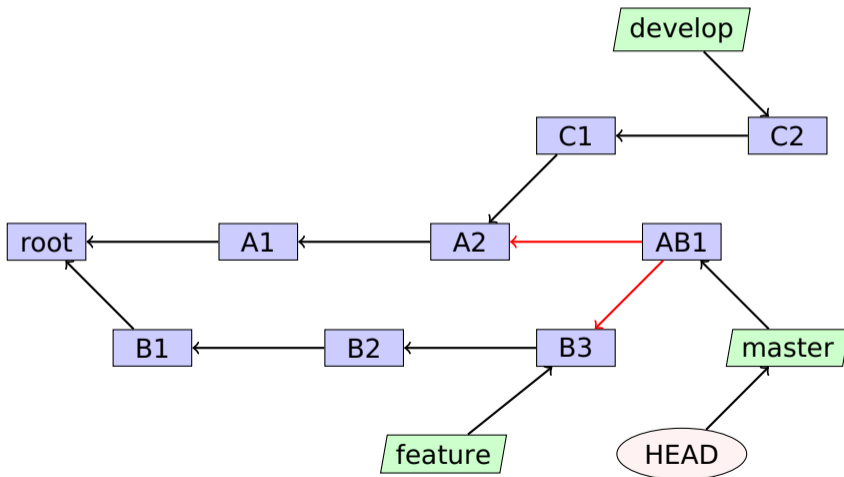

Fundamental Structure: Directed Acyclic Graph (DAG) of commits

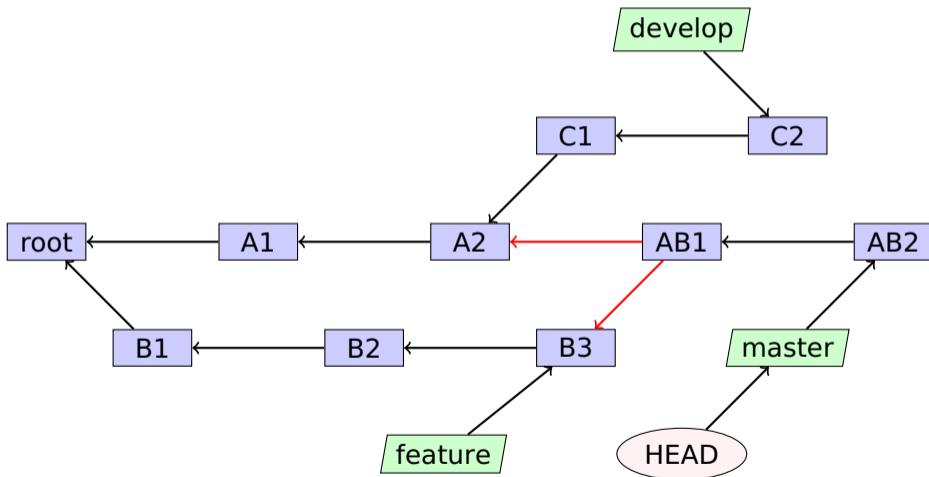

Fundamental Structure: Directed Acyclic Graph (DAG) of commits

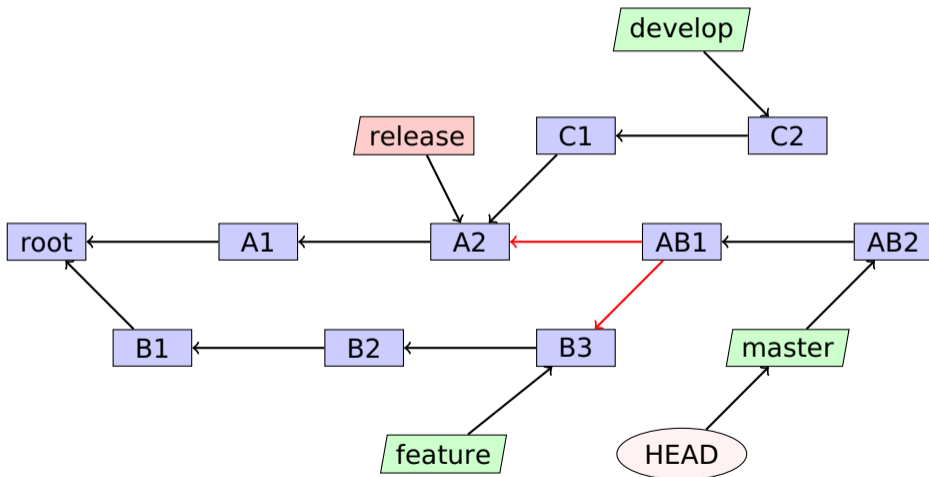

Installing Git

■ Linux distributions

Use your package manager of choice, e.g. `apt install git`

■ MacOS

Installation is possible via Homebrew: `brew install git`

■ Windows

Download and run the Git installer <https://git-scm.com/download/win>

Configuring Git

- First, we make sure that git is installed and ready to use:

```
git --version
```

- Each commit contains your name <NAME> and mail address <EMAIL>, so let's set those:

```
git config --global user.name "<NAME>"
```

```
git config --global user.email "<EMAIL>"
```

Omitting the `--global` switch would configure them for your current repo.

Creating and cloning repositories

- We can locally create a new, empty repository with

```
git init
```

The commit objects and other internal Git data will be stored in a hidden subdirectory `.git`.

- Usually we'd like to get a local copy of a remote repo at `<URL>`, done via

```
git clone <URL>
```

- There are many options to show the history leading to the commit `<C>`, e.g.:

```
git log -decorate -graph -oneline [<C>]
```

- ▶ Without specifying any commits, the history to the current commit is shown.
- ▶ There are many GUIs available as well, cf.
<https://git-scm.com/downloads/guis>

Creating commits

- The current state of the working directory can be queried as follows:

```
git status
```

This will show changed and new, untracked files.

- Best practice for files that are produced by your build:

- ▶ Include in `.gitignore` file and don't commit them.
- ▶ These files can be bootstrapped for most programming languages at gitignore.io.
- ▶ Examples: `*.o` for a C project or `*.pdf` for \LaTeX

- To *stage* all changed files, i.e. mark as part of the next commit:

```
git add .
```

- ▶ Replace `.` by a filename (pattern) to be more specific

- Finally, we can create the new commit with:

```
git commit -m "<MESSAGE>"
```

Local and remote branches

- Let's first get an overview of the available branches:

```
git branch
```

- With the `-a` switch we get *remote tracking* branches as well.

- A new branch `<BRANCH>` can be created with

```
git branch <BRANCH>
```

- ...and selected as the current one (i.e. representing the working tree) with

```
git checkout <BRANCH>
```

- In order to merge in the commits from `<OTHER_BRANCH>` we use

```
git merge <OTHER_BRANCH>
```

- ▶ Git is really smart about automatically resolving merge conflicts, at least for text files.
- ▶ If this fails, we have to manually edit the colliding files and then create the merge commit.

Local and remote branches

- Remote repositories can be shown with:

```
git remote
```

- ▶ With the `-v` switch each URL is shown as well.

- When cloning a git repo, the source is automatically configured as the remote origin.

- We can configure a new remote <REMOTE> at <URL> as follows:

```
git remote add <REMOTE> <URL>
```

- The <URL> can be given by

- ▶ a web tool like *GitHub*, *GitLab* or *Gitea* or
- ▶ the path to a *bare* repo (created with `git init --bare` and not containing a working tree).

Local and remote branches

- Showing branches with full verbosity reveals *remote tracking branches*:

```
git branch -vv
```

Again, these are automatically created when cloning from a remote repo.

- In order to update the remote tracking branch:

```
git fetch
```

- This can be combined to automatically merge into the local branch:

```
git pull
```

- Finally, we can upload locally new commits to the remote branch with:

```
git push
```

- Tracking can be set manually, e.g. for <BRANCH> to track <REMOTE> with:

```
git push -u <REMOTE> <BRANCH>
```